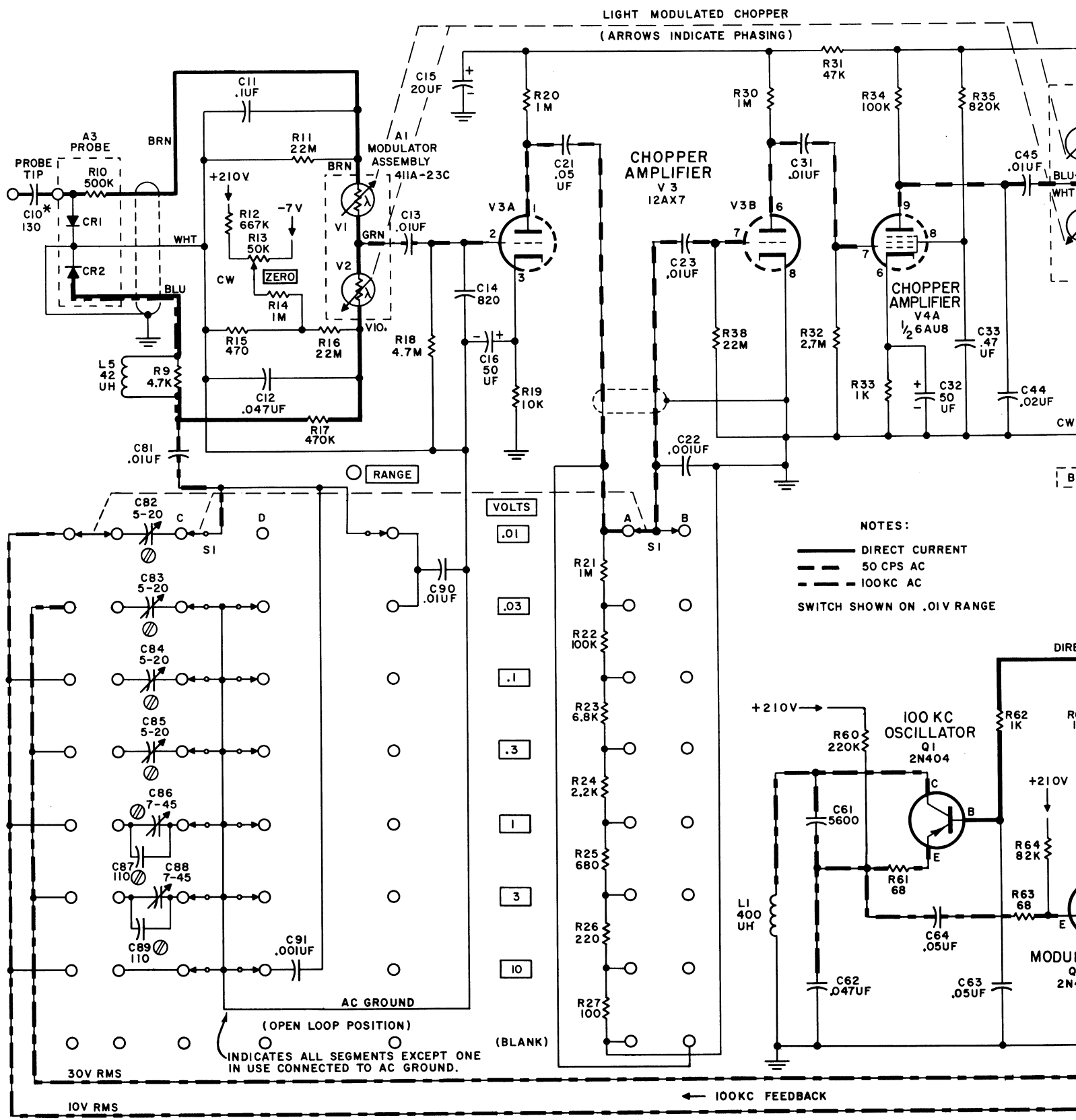

Figure 5-6. Power Supply



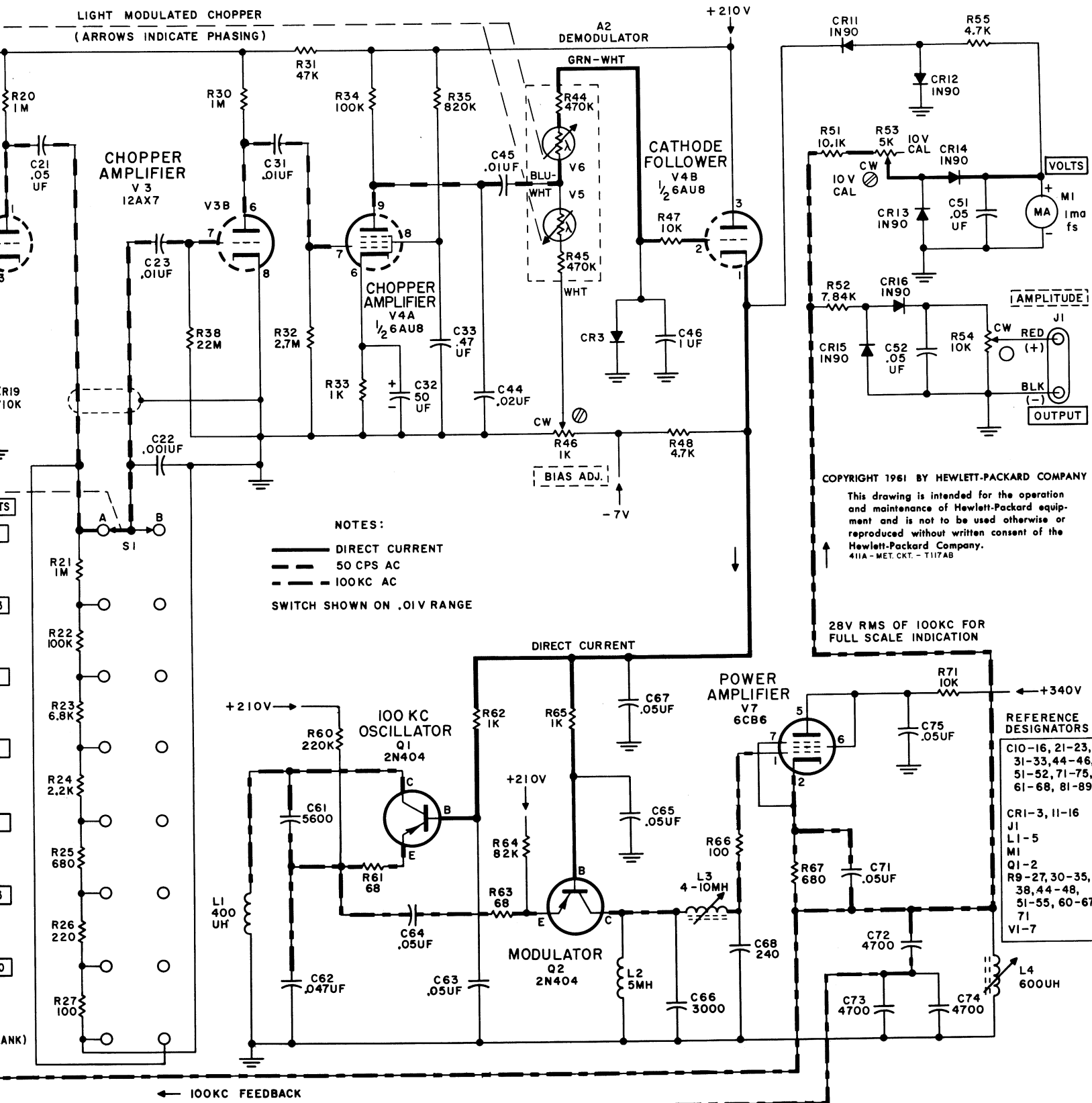

Figure 5-7. Voltmeter
5-11/5-1